



Speaker Includes:

- 8 inch 120W coaxial driver
- 120W transformer
- Plastic enclosure (attached)
- Press-fit grille, scrim, pull-tool

UL1480A
General Signaling, USA
CSA C22.2 No.205-12
General Signaling, Canada



Versatile Mounting Options: The speaker's built-in bracket assembly (hidden by top cover) enables it to hang from cable or pipe. Threaded insert points on sides allow the addition of a U-bracket for wall or truss-mount. *Order mounting hardware separately—installer to furnish pipe and/or other mounting hardware, as needed.*



ESP Series Pendant Speakers are engineered to acoustically match the ES Series of recessed speakers, enabling the integration of exceptional performance with even coverage no matter the type of architecture encountered. ESP speakers feature a built-in bracket for mounting with pipe or cable but they also have threaded insert points to add a U-bracket for wall or truss-mount. The sleek design, quality performance and versatile mounting options make the ESP Series suitable for a wide variety of applications that require clear speech and full frequency music.

MODEL DESCRIPTION:

Model ESP-82TW produces excellent intelligibility for speech and full frequency response for music making it ideal for retail, commercial, industrial, institutional and even some residential applications. This self-contained pendant or bracket-mount speaker system with 8" coaxial driver has a high-frequency horn-loaded silk dome tweeter for the kind of crisp, high-frequency response expected from high quality coaxial speakers. The ported enclosure is tuned for extended low-frequency response, while the speaker's wide dispersion can actually reduce the number of speakers required to produce even coverage in distributed speaker systems.

FEATURES:



- **Driver:** 8" 120W coaxial driver
- **Transformer:** 120W transformer with tap selector switch mounted behind grille. Tap selections for 25V, 70V or 100V speaker systems, and 4 ohm (UL minimum) transformer bypass position.
- **Grille:** Fine mesh 20-gauge CRS press-fit grille with UV-rated white powder coating includes scrim and pull tool.
- **Enclosure:** The tapered enclosure is durable white ABS plastic with matching magnetic top cover to hide wiring connections and rigging hardware.
 - Ported enclosure tuned for extended bass response.

- Removable (4 pin) Phoenix-style connector with two terminals for input to speaker and two parallel terminals for output to next speaker in string.
- The transformer selector switch is located on the bottom baffle, behind the grille.
- A built-in bracket assembly accommodates hanging from cable or pipe.

INSTALLATION:

This speaker can be mounted with cable, pipe or U-bracket. The speaker's built-in bracket assembly (hidden by top cover) enables it to hang from cable or pipe. Alternately, threaded insert points on sides accept a U-bracket for wall or truss-mount. See instruction sheets for more information. Order all mounting hardware separately – installer to furnish pipe and/or other mounting hardware, as needed.

ACCESSORIES: (order separately)

- **ESP-CBL Grapple Hanging Cables:** The cable kit includes two Grapple No. 2 hook-end hanging cables with quick-install Express fasteners, each with a load rating of 100 lbs. (5:1 safety factor). In a typical cable installation, one cable handles primary suspension, while the second serves as a safety cable (required). In pipe installation, one cable serves as the safety cable (required) for the pipe-mounted speaker (the kit accommodates two speakers mounted this way). 
- **ESP-8-BRKTW U-Bracket (white):** The kit includes a bracket and silicone spacers to create a flat surface on each side of the tapered enclosure. Knobs are used to screw the bracket to the speaker at threaded insert points. See the accessory spec sheet for more information. 
- **ESP-8-PG Paint Guards:** Pack of 10 plastic paint guards for 8 inch speakers.

FEATURES:



8" 120W Coaxial Driver: The driver has a high-frequency horn-loaded silk dome tweeter for crisp response.



Tapered Enclosure: Durable ABS plastic enclosure has a magnetic top to hide wiring connections.

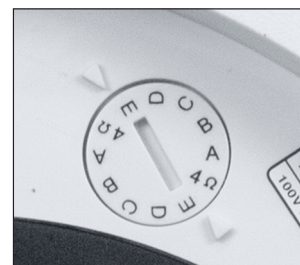

120W Transformer: The transformer has a front tap selector switch protected behind the press-fit grille.



Fine Mesh Grille: Press the grille into position after tap selections are made. The grille includes scrim and pull tool.

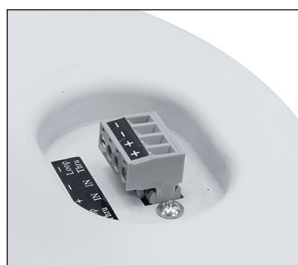

Phoenix Style Connector: Removable Phoenix style connector with two terminals for input and two terminals for output.

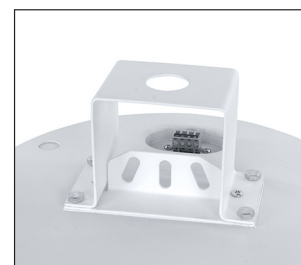

Bracket Assembly: The speaker's bracket is ready for cable or pipe installation, or you can use the side knockouts to add a U-bracket for wall- or truss-mount.

INSTALLATION METHODS:



Cable Installation: Order Gripple cable accessory kit [ESP-CBL](#) to mount the speaker with cables (primary and safety). Other mounting hardware is not included.



Pipe Installation: Use the speaker's bracket assembly to mount to pipe and safety cable. Pipe, fittings, cable, and other mounting hardware are not included.



U-Bracket Installation: Order U-bracket accessory kit [ESP-8-BRKTW](#) to mount speaker to wall or truss. Other mounting hardware is not included.

WARNING! Pendant-mount speaker installation should only be performed by experienced qualified professionals with a complete working knowledge of load-rated hardware and safe installation, mounting, and rigging techniques. Improperly installed equipment can result in property damage, personal injury, death, and/or liability for the installing contractor. The speaker system must be mounted in accordance with all local, state, and federal building codes and regulations and the installation must conform to industry standard practices. It is the responsibility of the installer to properly select all installation hardware, rigging hardware, and safety or restraint cables to be used. BEFORE INSTALLATION, it is the responsibility of the installer to consult a licensed mechanical or structural engineer to evaluate and certify the structural integrity and safety of any mounting method and the suitability of that method to be used to mount the pendant loudspeaker to the building structure in this particular installation. All speaker rigging systems must be designed with a minimum of a 5X safety factor. Lowell Manufacturing Company is not responsible for the use, misuse, misapplication, or unsafe installation of any loudspeaker that it has manufactured.



TECHNICAL:

DRAWINGS

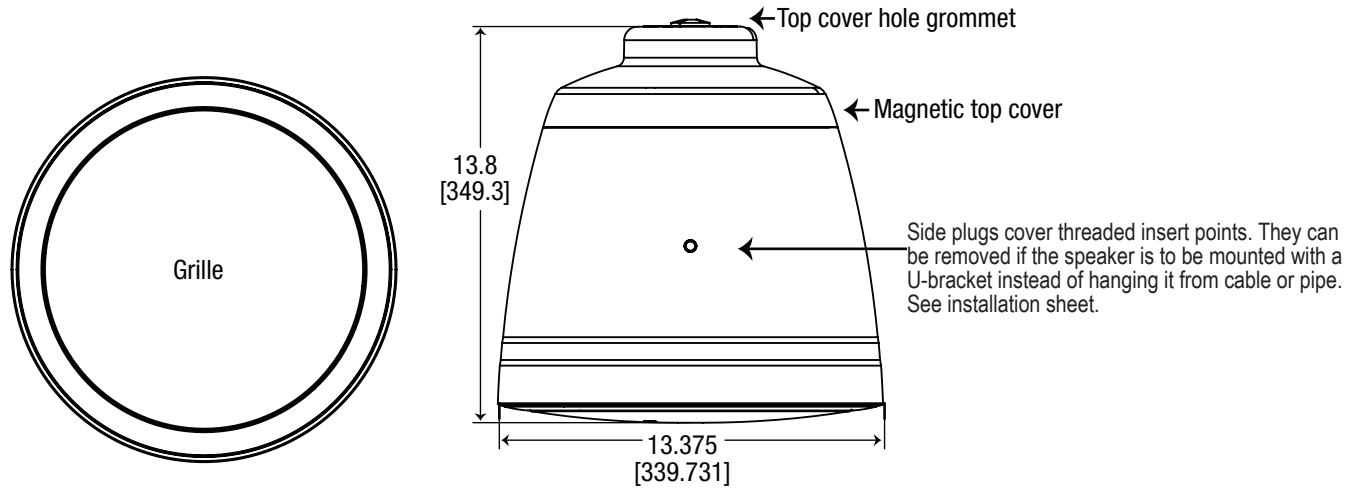

SPL vs. FREQUENCY (1W/1M)

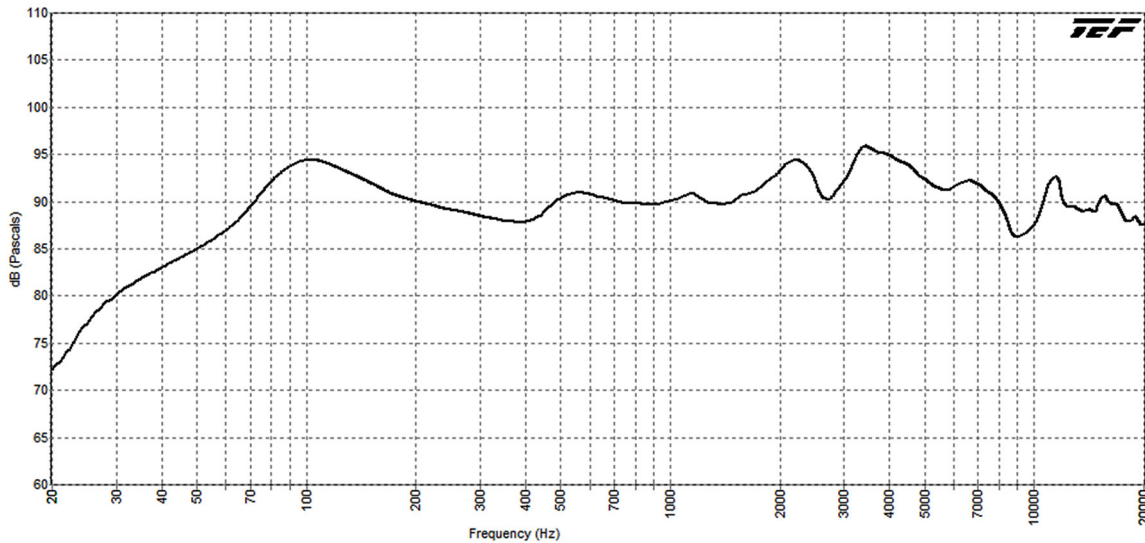

IMPEDANCE

Impedance reading expected from a typical 1kHz impedance meter is 9.5 ohms with the selector switch in the 4 ohm position.

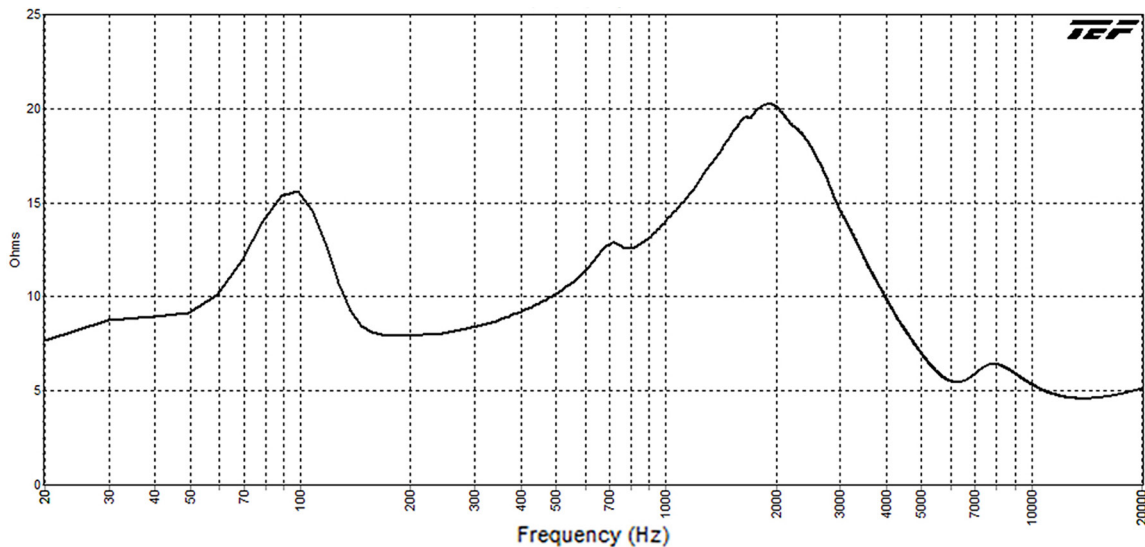

POLAR DATA 180° (full space mounting)

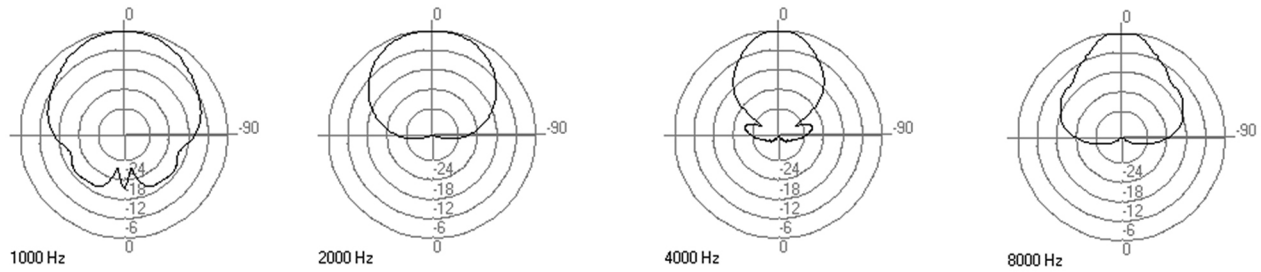

PERFORMANCE:

| | |
|---------------------------|--|
| Power Handling: | 120W RMS (at 8 ohms) measured per EIA Standard RS-426B |
| Sensitivity: | 90.0 dB log average SPL (at 8 ohms) @ 1W/1M over the frequency response range, measured in full-space. |
| Maximum SPL: | 110.8 dB (calculated based on power rating and measured 8 ohm sensitivity). |
| Impedance: | 8 ohms (nominal), 4.6 ohms @14 kHz (min.) |
| Frequency Response: | 64Hz–20kHz ±6dB |
| Conical Dispersion Angle: | 105° conical @ 2kHz octave (-6dB) |
| Crossover Frequency: | 1.8kHz |
| Transformer Taps: | 100V (120, 60, 30, 15W); 70V (120, 60, 30, 15, 7.5W); 25V (15, 7.5, 3.75, 1.88, 0.94W) |

PHYSICAL: (Full Range Speaker)

| | |
|--------------------------|-------------------|
| Woofer Cone: | Coated paper cone |
| Surround: | Rubber |
| Woofer Magnet Weight: | 19.2 oz. (544.7g) |
| Woofer Voice Coil Dia.: | 1.2" (30.55mm) |
| Tweeter Cone: | Silk dome |
| Tweeter Magnet Weight: | 0.45 oz. (12.8g) |
| Tweeter Voice Coil Dia.: | 1" (25.4mm) |

MECHANICAL:

| | |
|--------------------------------|---|
| Input Terminals: | 4-conductor removable Phoenix-style connector |
| Net Weight (speaker & grille): | 15.6 lbs. (7.08kg) |
| Shipping Weight: | 19.4 lbs. (8.80kg) |
| Height: | 13.8 in. (349.3mm) |
| Diameter: | 13.375 in. (339.731mm) |

MOUNTING:

| | |
|-------------------|---|
| Cable Suspension: | Requires accessory ESP-CBL and additional mounting hardware to attach to the building structure, supplied by the installer. |
| Pipe Suspension: | Requires half of accessory ESP-CBL (one cable for use as a safety cable) plus pipe and fittings to attach to the building structure, supplied by the installer. |
| U-Bracket Mount: | Requires accessory ESP-8-BRKTW plus mounting hardware supplied by the installer. |

TEST METHODOLOGIES: Lowell ESP Series speaker systems are thoroughly tested to provide specifiers and contractors with accurate data. Test equipment includes the GoldLine TEF-20 analyzer.

- Power Handling: specification is based on E.I.A. Standard RS-426B.
- Frequency Response: describes the usable response range defined by a ± 6dB window, which is useful in predictive engineering calculations.
- Sensitivity: is a computer calculation of the log average sound pressure level (SPL) over the entire engineering bandwidth as given in the Frequency Response (± 6dB).
- Maximum SPL: is calculated based on the Power Handling and the measured log average Sensitivity where Maximum SPL = (Sensitivity @ 1W1M) + 10 log (Power Handling).
- Dispersion Angle: is defined as the angle of coverage that is no more than 6dB down from the on-axis value averaged over the 2kHz octave band. Since speech intelligibility is dependent upon the 2kHz octave, this specification is useful in designing voice reinforcement and music systems that provide even coverage and intelligibility. The polar plots illustrate how the system performs when hung in free space (360°) or half-space (180°) in the case of a recessed speaker.



A&E SPECIFICATIONS:

The loudspeaker shall be Lowell ESP-82TW, which shall include a high-performance 8" coaxial driver, ported bass reflex enclosure and press-fit grille for pendant or U-bracket mount. Frequency response shall be 64Hz-20kHz \pm 6dB. Sensitivity shall be 90.0dB log average @1W/1M over the frequency response range, measured in full-space. The speaker shall be constructed of a coated paper cone with rubber surround and a silk dome tweeter. The woofer magnet weight shall be a minimum of 19.2 oz. (544.7g) and the woofer voice coil diameter shall be 1.2" (30.55mm). The transformer shall have primary taps for 100V (120, 60, 30, 15 watt); 70V (120, 60, 30, 15, 7.5 watt); and 25V (15, 7.5, 3.75, 1.88, 0.94 watt) with a selector switch mounted on the front under the grille that will include a 4ohm (UL minimum) transformer bypass position. The enclosure shall be white ABS plastic featuring a main body, magnetic cover, and bottom baffle where the driver shall be mounted. The enclosure shall feature a bracket assembly to accommodate cable or pipe hanging installations (cable/pipe not included). A four-conductor Phoenix style removable connector shall be located under the magnetic cover to allow input wiring and parallel output wiring to the next speaker. The unit shall include a fine mesh 20-gauge CRS press-fit grille with UV rated powder coating (white), scrim and pull tool.

ESP SERIES: Pendant Speaker Overview

| ESP SERIES: Pendant Speaker Overview | | | | | | | Accessories (order separately) | | |
|--------------------------------------|-----------------------------|-------------|----------------|------------------|------------------|------------------------|--------------------------------|-------------------|-----------------|
| Model No. | Driver | Transformer | Overall Height | Overall Diameter | Net Weight | Enclosure/Grille Color | U-Bracket | Gripple Cable Kit | Paint Guards |
| ESP-62TB | 6-1/2" 50W coaxial | 32W | 12.6" | 10.0" | 8.3 lbs. | Black | ESP-6-BRKTB | ESP-CBL | ESP-6-PG |
| ESP-62TW | 6-1/2" 50W coaxial | 32W | 12.6" | 10.0" | 8.3 lbs. | White | ESP-6-BRKTW | ESP-CBL | ESP-6-PG |
| ESP-82TB | 8" 120W coaxial | 120W | 13.8" | 13.375" | 15.6 lbs. | Black | ESP-8-BRKTB | ESP-CBL | ESP-8-PG |
| <i>This spec</i> ESP-82TW | 8" 120W coaxial | 120W | 13.8" | 13.375" | 15.6 lbs. | White | ESP-8-BRKTW | ESP-CBL | ESP-8-PG |
| ESP-82CDTB | 8" 150W coaxial compression | 120W | 13.8" | 13.375" | 19.1 lbs. | Black | ESP-8-BRKTB | ESP-CBL | ESP-8-PG |
| ESP-82CDTW | 8" 150W coaxial compression | 120W | 13.8" | 13.375" | 19.1 lbs. | White | ESP-8-BRKTW | ESP-CBL | ESP-8-PG |

NOTES: U-brackets available in black (BRKTB) and white (BRKTW).
Gripple Cable Kit includes two cables (one primary, one safety).
Paint guards sold in packs of 10.

