



features

- **Description:** The wall triangle bracket provides support for a cable ladder.
- **Width:** 18.00 in.
- **Construction:**
 - High strength 14-gauge steel
 - Modular assembly (3 pieces)
 - Color: Black
- **Static Load Rating:** Up to 400 lbs.

a&e specifications

The 18 in. wide cable ladder shall include a wall triangle support bracket, Lowell Model #CLA-18WT, which shall be a 3-piece modular assembly (steel with black finish).

technical drawings

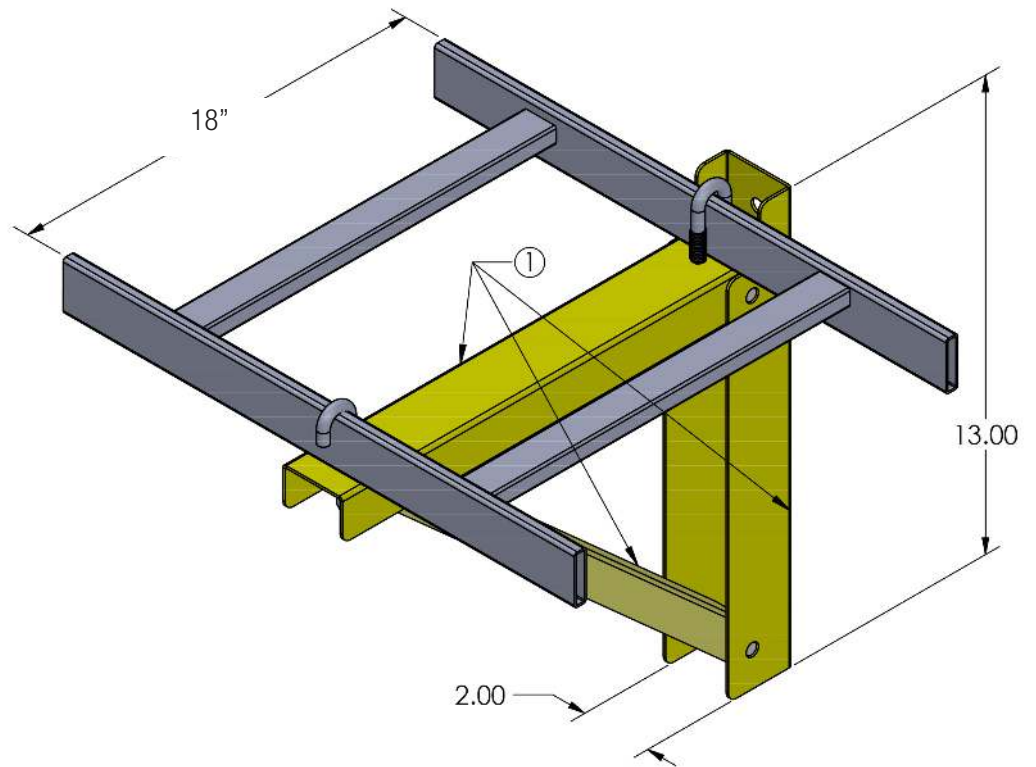

Cable ladder series summary

Model No.	Description	Weight	Function
CABLE LADDERS & ACCESSORIES — 12" Wide			
CL-1210	Straight ladder – 12"W x 10'L (approx.)	24.47 lbs	Straight section
CL-12HT	Horizontal turn ladder – 12"W	8.05 lbs	90 degree turn with minimum cable bend radius
CL-12VT	Vertical turn ladder (I/O bend) – 12"W	4.8 lbs	Changes direction of cable ladder
CLA-12RRP	Relay rack plate kit – 12"W	3.12 lbs	Secures cable ladder to top of 3" channel relay rack**
CLA-12WA	Wall angle bracket – 12"W	1.96 lbs	Provides perpendicular wall support for cable ladder
CLA-12WT	Wall triangle bracket – 12"W	4.15 lbs	Provides wall support (400 lbs. static load) for cable ladder
CLA-12RD	Cable radius drop – 12"W	1.90 lbs	Allows cable exit with proper bend radius

CABLE LADDERS & ACCESSORIES — 18" Wide

CL-1810	Straight ladder – 18"W x 10'L (approx.)	27.75 lbs	Straight section
CL-18HT	Horizontal turn ladder – 18"W	10.50 lbs	90 degree turn with minimum cable bend radius
CL-18VT	Vertical turn ladder (I/O bend) – 18"W	5.6 lbs	Changes direction of cable ladder
CLA-18RRP	Relay rack plate kit – 18"W	4.20 lbs	Secures cable ladder to top of 3" channel relay rack**
CLA-18WA	Wall angle bracket – 18"W	2.70 lbs	Provides perpendicular wall support for cable ladder
CLA-18WT	Wall triangle bracket – 18"W	5.92 lbs	Provides wall support (400 lbs. static load) for cable ladder
CLA-18RD	Cable radius drop – 18"W	2.84 lbs	Allows cable exit with proper bend radius

ADDITIONAL HARDWARE (not size specific)

Securing Ladder to Rack

CLP-7	Rack adaptor panel, 7U	4 lbs	Mounts cable ladder to 7U opening in rack top
CLP-10	Rack adaptor panel, 10U	4 lbs	Mounts cable ladder to 10U opening in rack top
CLH-SK46	Stand-off elevation kit (4"-6")	12.00 lbs	Elevates cable ladder above rack (4" or 6")
CLH-JB3	J-bolt kit, 5/16 x 3"	0.31 lbs	Holds cable ladder to rack

Securing Ladder to Wall, Floor, Ceiling

CLH-VWB	Vertical wall brackets	0.56 lbs	Anchors cable ladder to wall
CLH-CK	Ceiling-mount kit	0.88 lbs	Suspends cable ladder from ceiling
CLH-FB	Floor-mount brackets	3.22 lbs	Mounts cable ladder to floor

Connecting Ladder Sections

CLH-SKB	Butt splice kit	0.47 lbs	Fastens cable ladder sections end-to-end
CLH-SKS	Swivel / adjustable splice kit	1.90 lbs	Fastens cable ladder sections providing adjustable bend
CLH-SKT	T-junction bracket kit	0.68 lbs	Fastens cable ladder sections at 90 degree intersection
CLH-SKA	Adjustable splice kit (special) *	2.0 lbs	Fastens cable ladder sections creating horizontal intersection

Misc. Protection

CLH-GSK	Grounding strap kit	0.25 lbs	Provides grounding across cable ladder
CLH-EC	Ladder end caps (1pr)	0.35 lbs	Covers end of cable ladder

*Installer may cut ladder ends at special angles to fit around an obstacle

**See Lowell LRR Series racks