



MADE IN THE USA



CERTIFIED US STEEL



The base features casters with a specially formulated rubber tread that won't mar fine floors.

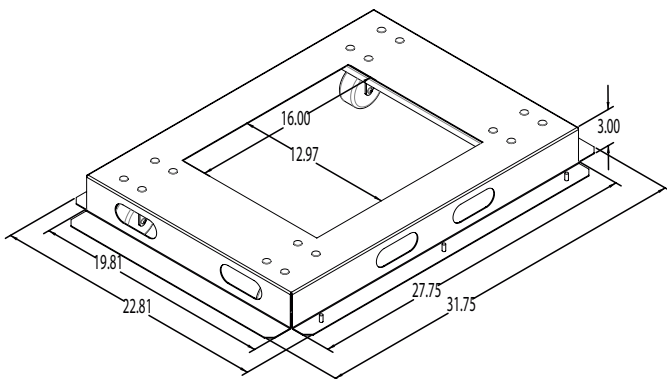

### features . . . . .

- **Description:** Designed to mount inside a rack frame to provide mobility and a floor positioned flush to bottom rack space. Often specified to support extra heavy equipment that is mounted in the lowest rack position.
- **Overall Height:** 3.00" [76]
- **Overall Depth:** 31.75" [806]
- **Overall Width:** 22.81" [579]
- **Construction:** Rugged 14-gauge, fully-welded, steel construction. Black wrinkle powder epoxy finish.
- **Cable Management:** Easy cable access through center opening. Cable pass-through openings on back match up to openings on matching LER and LGR Series racks. Cable pass-through openings on sides match up to openings on matching LGR Series racks.
- **Castors:** Four non-locking 3" swivel casters with specially formulated rubber tread that won't mar fine floors like wood, marble or tile. Total load rating is 800 lbs.
- **Hardware:** Includes hardware for bolt-on installation.
- **Origin:** Made in the USA
- For use with LER, LFR and LGR Series racks.  
*Do not use with seismic-certified racks.*
- Increases rack height 1.50"

### a&e specifications . . . . .

The rack's mobile base shall be Lowell Model LMB-32F, which shall be of an inner platform design that mounts inside the rack frame, adding mobility and a floor positioned flush to bottom rack space. Construction shall be 14-gauge welded steel with a center opening and black wrinkle powder epoxy finish. Side openings shall match openings on LGR Series racks for cable pass-through. Four heavy-duty (3") non-locking swivel casters shall be positioned inside the platform. They shall feature a specially formulated rubber tread that won't mar fine floors. Casters shall have a total load rating of 800 lbs. Increase in overall rack height shall be 1.50". Mounting hardware shall be included.

### Model Summary

Model No.	Description	Overall Width	Overall Depth	Overall Height	Center Opening	Weight
LMB-27F	Mobile Base for 27"D rack	22.81 in / 579 mm	26.75 in / 679 mm	3 in / 76 mm	12.97 x 11 in / 329 x 279 mm	28 lbs / 12.7 kg
LMB-32F	Mobile Base for 32"D rack	22.81 in / 579 mm	31.75 in / 806 mm	3 in / 76 mm	12.97 x 16 in / 329 x 406 mm	31 lbs / 14.0 kg
LMB-36F	Mobile Base for 36"D rack	22.81 in / 579 mm	35.75 in / 908 mm	3 in / 76 mm	12.97 x 20 in / 329 x 508 mm	35 lbs / 15.8 kg

One rack unit (RU or U) = 1.75 inches or 44.45 mm.

