

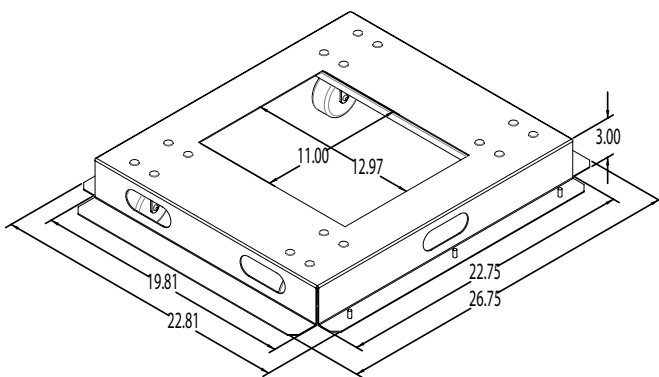

The base features 3" swivel casters



features

- **Description:** Designed to mount inside a rack frame to provide a floor positioned flush to bottom rack space. Often specified to support extra heavy equipment that is mounted in the lowest rack position.
- **Overall Height:** 3.00" [76]
- **Overall Depth:** 26.75" [679]
- **Overall Width:** 22.81" [579]
- **Construction:** Rugged 14-gauge, fully-welded, steel construction. Black wrinkle powder epoxy finish
- **Cable Management:** Easy cable access through center opening. Cable pass-through openings on back match up to openings on matching LER and LGR Series racks. Cable pass-through openings on sides match up to openings on matching LGR Series racks
- **Casters:** Four non-locking 3" swivel casters. Total load rating is 1400 lbs.
- **Hardware:** Includes hardware for bolt-on installation
- **Origin:** Made in the USA
- For use with LER, LFR and LGR Series racks.
Do not use with seismic-certified racks.
- Increases rack height 1.25".

a&e specifications

The rack's mobile base shall be Lowell Model LMB-27, which shall be of an inner platform design that mounts inside the rack frame, adding a floor positioned flush to bottom rack space. Construction shall be 14-gauge welded steel with a center opening and black wrinkle powder epoxy finish. Side openings shall match openings on LGR Series racks for cable pass-through. Four heavy-duty (3") non-locking swivel casters shall be positioned inside the platform. Casters shall have a total load rating of 1400 lbs. Increase in overall rack height shall be 1.25". Mounting hardware shall be included.

Model Summary

Model No.	Description	Overall Width	Overall Depth	Overall Height	Center Opening	Weight
LMB-27	Mobile Base for 27"D rack	22.81 in / 579 mm	26.75 in / 679 mm	3 in / 76 mm	12.97 x 11 in / 329 x 279 mm	28 lbs / 12.7 kg
LMB-32	Mobile Base for 32"D rack	22.81 in / 579 mm	31.75 in / 806 mm	3 in / 76 mm	12.97 x 16 in / 329 x 406 mm	31 lbs / 14.0 kg
LMB-36	Mobile Base for 36"D rack	22.81 in / 579 mm	35.75 in / 908 mm	3 in / 76 mm	12.97 x 20 in / 329 x 508 mm	35 lbs / 15.8 kg
LMB-42	Mobile Base for 42"D rack	22.81 in / 579 mm	41.75 in / 1060 mm	3 in / 76 mm	12.97 x 26 in / 329 x 660 mm	37 lbs / 16.7 kg

One rack unit (RU or U) = 1.75 inches or 44.45 mm.

